



## **Instructions for installation and use**

Built-in Microwave  
**5MG17190IN**

# PRECAUTIONS TO AVOID POSSIBLE EXPOSURE TO EXCESSIVE MICROWAVE ENERGY

(a) Do not attempt to operate this oven with the door open since this can result in harmful exposure to microwave energy. It is important not to break or tamper with the safety interlocks.

(b) Do not place any object between the oven front face and the door or allow soil or cleaner residue to accumulate on sealing surfaces.

(c) **WARNING:** If the door or door seals are damaged, the oven must not be operated until it has been repaired by a competent person.

## ADDENDUM

If the apparatus is not maintained in a good state of cleanliness, its surface could be degraded and affect the lifespan of the apparatus and lead to a dangerous situation.

## Specifications

Model:	5MG17190IN
Rated Voltage:	230V~50Hz
Rated Input Power(Microwave):	1550W
Rated Output Power(Microwave):	1000W
Rated Input Power(Grill):	1100W
Rated Input Power(Convection):	2500W
Oven Capacity:	34 L
Turntable Diameter:	Ø315mm
External Dimensions:	595×468 ×388mm
Net Weight:	Approx. 22kg

## **IMPORTANT SAFETY INSTRUCTIONS WARNING**

To reduce the risk of fire, electric shock, injury to persons or exposure to excessive microwave oven energy when using your appliance, follow basic precautions, including the following:

1. Read and follow the specific: "PRECAUTIONS TO AVOID POSSIBLE EXPOSURE TO EXCESSIVE MICROWAVE ENERGY".
2. This appliance can be used by children aged from 8 years and above and persons with reduced physical, sensory or mental capabilities or lack of experience and knowledge if they have been given supervision or instruction concerning use of the appliance in a safe way and understand the hazards involved. Children shall not play with the appliance. Cleaning and user maintenance shall not be made by children unless they are older than 8 and supervised. Children less than 8 years of age shall be kept away unless continuously supervised.
3. Keep the appliance and its cord out of reach of children less than 8 years.
4. If the supply cord is damaged, it must be replaced by the manufacturer, its service agent or similarly qualified persons in order to avoid a hazard. ( For appliance with type Y attachment)
5. **WARNING:** Ensure that the appliance is switched off before replacing the lamp to avoid the possibility of electric shock.

6. WARNING: It is hazardous for anyone other than a competent person to carry out any service or repair operation that involves the removal of a cover which gives protection against exposure to microwave energy.
7. WARNING: Liquids and other foods must not be heated in sealed containers since they are liable to explode.
8. When heating food in plastic or paper containers, keep an eye on the oven due to the possibility of ignition.
9. Only use utensils that are suitable for use in microwave ovens.
10. If smoke is emitted, switch off or unplug the appliance and keep the door closed in order to stifle any flames.
11. Microwave heating of beverages can result in delayed eruptive boiling, therefore care must be taken when handling the container.
12. The contents of feeding bottles and baby food jars shall be stirred or shaken and the temperature checked before consumption, in order to avoid burns.
13. Eggs in their shell and whole hard-boiled eggs should not be heated in microwave ovens since they may explode, even after microwave heating has ended.
14. The oven should be cleaned regularly and any food deposits removed.
15. Failure to maintain the oven in a clean condition could lead to deterioration of the surface that could adversely affect the life of the appliance and possibly result in a hazardous situation.

16. Only use the temperature probe recommended for this oven. (for ovens provided with a facility to use a temperature-sensing probe.)

17. The microwave oven must be operated with the decorative door open. (for ovens with a decorative door.)

18. This appliance is intended to be used in household and similar applications such as:

-staff kitchen areas in shops, offices and other working environments;

-by clients in hotels, motels and other residential type environments;

-farm houses;

-bed and breakfast type environments.

19. The microwave oven is intended for heating food and beverages. Drying of food or clothing and heating of warming pads, slippers, sponges, damp cloth and similar may lead to risk of injury, ignition or fire.

20. Metallic containers for food and beverages are not allowed during microwave cooking.

21. The appliance shall not be cleaned with a steam cleaner.

22. Care should be taken not to displace the turntable when removing containers from the appliance. (For fixed appliances and built-in appliances being used equal or higher than 900mm above the floor and having detachable turntables. But this is not applicable for appliances with horizontal bottom hinged door.)

23. The microwave oven is intended to be used built-in.
24. Steam cleaner is not to be used.
25. Surface of a storage drawer can get hot.
26. **WARNING:** The appliance and its accessible parts become hot during use. Care should be taken to avoid touching heating elements. Children less than 8 years of age shall be kept away unless continuously supervised.
27. During use the appliance becomes hot. Care should be taken to avoid touching heating elements inside the oven.
28. **WARNING:** Accessible parts may become hot during use. Young children should be kept away.
29. The appliance must not be installed behind a decorative door in order to avoid overheating. (This is not applicable for appliances with decorative door.)
30. **WARNING:** When the appliance is operated in the combination mode, children should only use the oven under adult supervision due to the temperatures generated.
31. Do not use harsh abrasive cleaners or sharp metal scrapers to clean the oven door glass since they can scratch the surface, which may result in shattering of the glass.

**READ CAREFULLY AND KEEP FOR FUTURE REFERENCE**

# To Reduce the Risk of Injury to Persons Grounding Installation

## **DANGER**

Electric Shock Hazard  
Touching some of the internal components can cause serious personal injury or death. Do not disassemble this appliance.

## **WARNING**

Electric Shock Hazard  
Improper use of the grounding can result in electric shock. Do not plug into an outlet until appliance is properly installed and grounded.

This appliance must be grounded. In the event of an electrical short circuit, grounding reduces the risk of electric shock by providing an escape wire for the electric current. This appliance is equipped with a cord having a grounding wire with a grounding plug. The plug must be plugged into an outlet that is properly installed and grounded.

Consult a qualified electrician or serviceman if the grounding instructions are not completely understood or if doubt exists as to whether the appliance is properly grounded. If it is necessary to use an extension cord, use only a 3-wire extension cord.

1. A short power-supply cord is provided to reduce the risks resulting from becoming entangled in or tripping over a longer cord.
2. If a long cord set or extension cord is used:
  - 1)The marked electrical rating of the cord set or extension cord should be at least as great as the electrical rating of the appliance.
  - 2)The extension cord must be a grounding-type 3-wire cord.
  - 3)The long cord should be arranged so that it will not drape over the counter top or tabletop where it can be pulled on by children or tripped over unintentionally.

# CLEANING

Be sure to unplug the appliance from the power supply.

1. Clean the cavity of the oven after using with a slightly damp cloth.
2. Clean the accessories in the usual way in soapy water.
3. The door frame and seal and neighbouring parts must be cleaned carefully with a damp cloth when they are dirty.
4. Do not use harsh abrasive cleaners or sharp metal scrapers to clean the oven door glass since they can scratch the surface, which may result in shattering of the glass.
5. Cleaning Tip---For easier cleaning of the cavity walls that the food cooked can touch: Place half a lemon in a bowl, add 300ml (1/2 pint) water and heat on 100% microwave power for 10 minutes. Wipe the oven clean using a soft, dry cloth.

# UTENSILS

## CAUTION

### Personal Injury Hazard

It is hazardous for anyone other than a competent person to carry out any service or repair operation that involves the removal of a cover which gives protection against exposure to microwave energy.

See the instructions on "Materials you can use in microwave oven or to be avoided in microwave oven."

There may be certain non-metallic utensils that are not safe to use for microwaving. If in doubt, you can test the utensil in question following the procedure below.

Utensil Test:

1. Fill a microwave-safe container with 1 cup of cold water (250ml) along with the utensil in question.
2. Cook on maximum power for 1 minute.
3. Carefully feel the utensil. If the empty utensil is warm, do not use it for microwave cooking.
4. Do not exceed 1 minute cooking time.



## Materials you can use in microwave oven

Utensils	Remarks
Browning dish	Follow manufacturer's instructions. The bottom of browning dish must be at least 3/16 inch (5mm) above the turntable. Incorrect usage may cause the turntable to break.
Dinnerware	Microwave-safe only. Follow manufacturer's instructions. Do not use cracked or chipped dishes.
Glass jars	Always remove lid. Use only to heat food until just warm. Most glass jars are not heat resistant and may break.
Glassware	Heat-resistant oven glassware only. Make sure there is no metallic trim. Do not use cracked or chipped dishes.
Oven cooking bags	Follow manufacturer's instructions. Do not close with metal tie. Make slits to allow steam to escape.
Paper plates and cups	Use for short-term cooking/warming only. Do not leave oven unattended while cooking.
Paper towels	Use to cover food for reheating and absorbing fat. Use with supervision for a short-term cooking only.
Parchment paper	Use as a cover to prevent splattering or a wrap for steaming.
Plastic	Microwave-safe only. Follow the manufacturer's instructions. Should be labeled "Microwave Safe". Some plastic containers soften, as the food inside gets hot. "Boiling bags" and tightly closed plastic bags should be slit, pierced or vented as directed by package.
Plastic wrap	Microwave-safe only. Use to cover food during cooking to retain moisture. Do not allow plastic wrap to touch food.
Thermometers	Microwave-safe only (meat and candy thermometers).
Wax paper	Use as a cover to prevent splattering and retain moisture.

## Materials to be avoided in microwave oven

Utensils	Remarks
Aluminum tray	May cause arcing. Transfer food into microwave-safe dish.
Food carton with metal handle	May cause arcing. Transfer food into microwave-safe dish.
Metal or metal-trimmed utensils	Metal shields the food from microwave energy. Metal trim may cause arcing.
Metal twist ties	May cause arcing and could cause a fire in the oven.
Paper bags	May cause a fire in the oven.
Plastic foam	Plastic foam may melt or contaminate the liquid inside when exposed to high temperature.
Wood	Wood will dry out when used in the microwave oven and may split or crack.

# SETTING UP YOUR OVEN

## Names of Oven Parts and Accessories

Remove the oven and all materials from the carton and oven cavity.

Your oven comes with the following accessories:

Glass tray	1
Turntable ring assembly	1
Instruction Manual	1

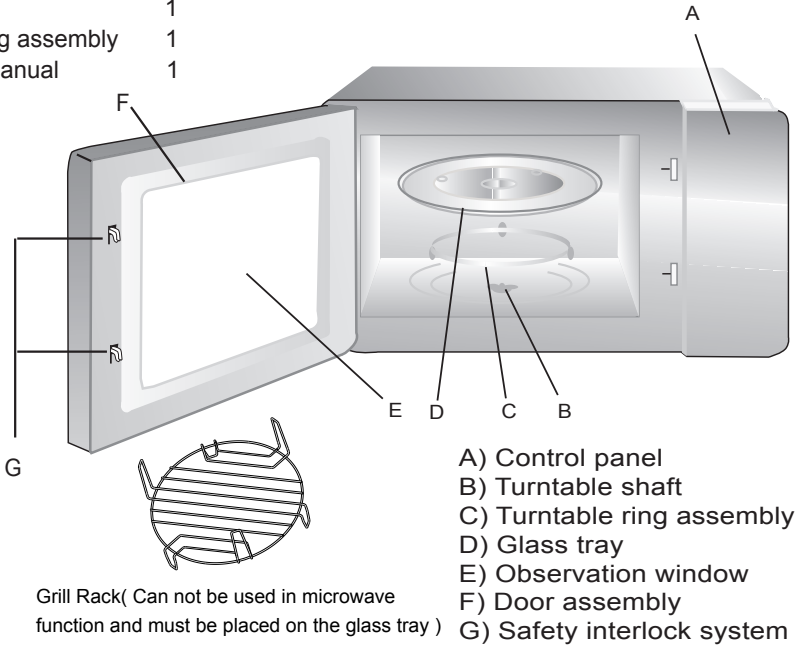

## Turntable Installation

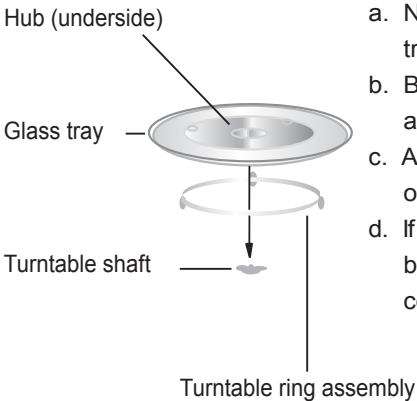

- Never place the glass tray upside down. The glass tray should never be restricted.
- Both glass tray and turntable ring assembly must always be used during cooking.
- All food and containers of food are always placed on the glass tray for cooking.
- If glass tray or turntable ring assembly cracks or breaks, contact your nearest authorized service center.

## **Installation and connection**

- 1.This appliance is only intended for domestic use.
- 2.This oven is intended for built-in use only. It is not intended for counter-top use or for use inside a cupboard.
3. Please observe the special installation instructions.
- 4.The appliance can be installed in a 60cm wide wall-mounted cupboard.
- 5.The appliance is fitted with a plug and must only be connected to a properly installed earthed socket.
- 6.The mains voltage must correspond to the voltage specified on the rating plate.
- 7.The socket must be installed and connecting cable must only be replaced by a qualified electrician. If the plug is no longer to accessible following installation, an all-pole disconnecting device must be present on the installation side with a contact gap of at least 3mm.
- 8.Adapters, multi-way strips and extension leads must not be used. Overloading can result in a risk of fire.

**The accessible surface may be hot during operation.**



# Installation Instructions

Please Read the Manual Carefully Before Installation

SCREW ————   
TRIM-KIT PLASTIC COVER ————   
COVER

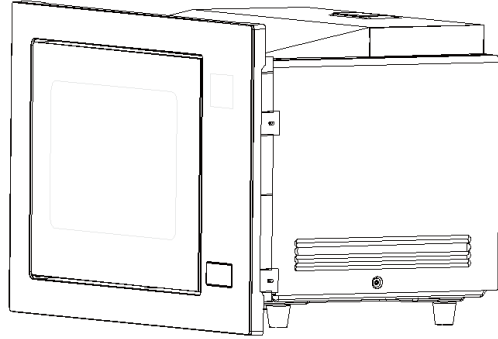

## Please Note

### Electrical connection

The oven is fitted with a plug and must be only connected to a properly installed earthed socket. In accordance with the appropriate regulations, the socket must only be installed and the connecting cable must only be replaced by a qualified electrician.

If the plug is no longer accessible following installation and all-pole isolating switch must be present on the installation side with a contact gap of at least 3mm.

## A. Built-in furniture

The built-in cabinet shall not have a rear wall behind the appliance.  
Minimum installation height is 85cm.  
Do not cover ventilation slots and air intake points.

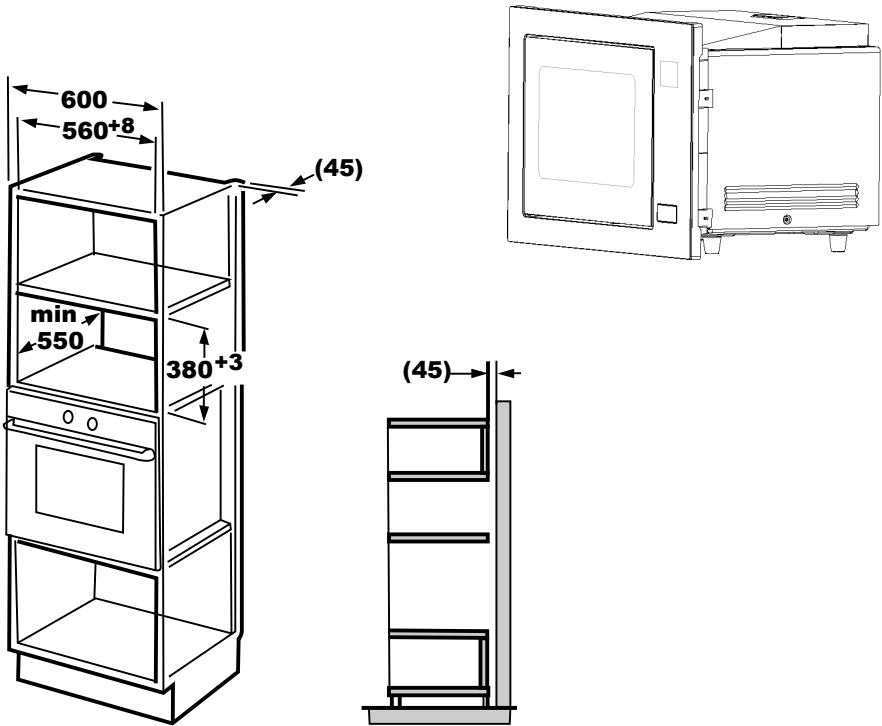

## B. Install the Oven

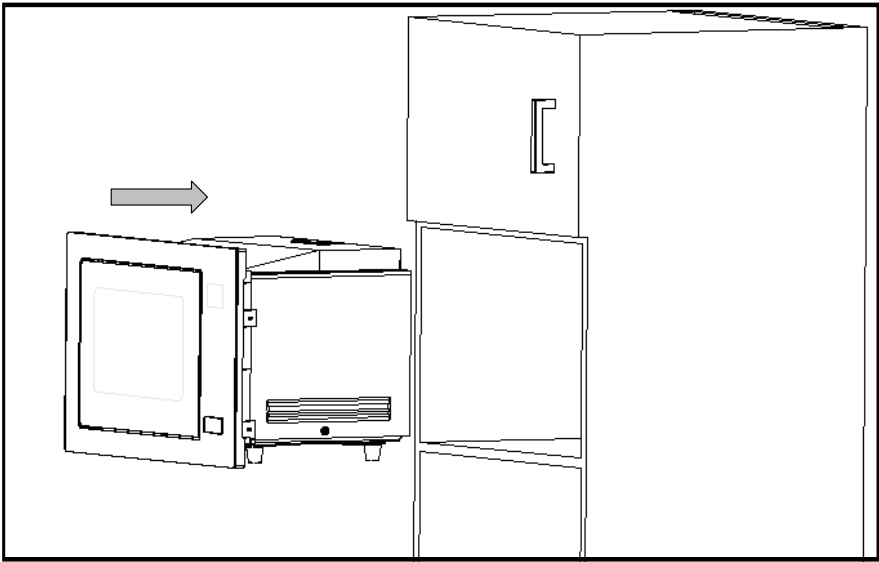

1. ● Do not trap or kink the power cord.  
● Make sure that the oven is installed in the center of the cabinet.

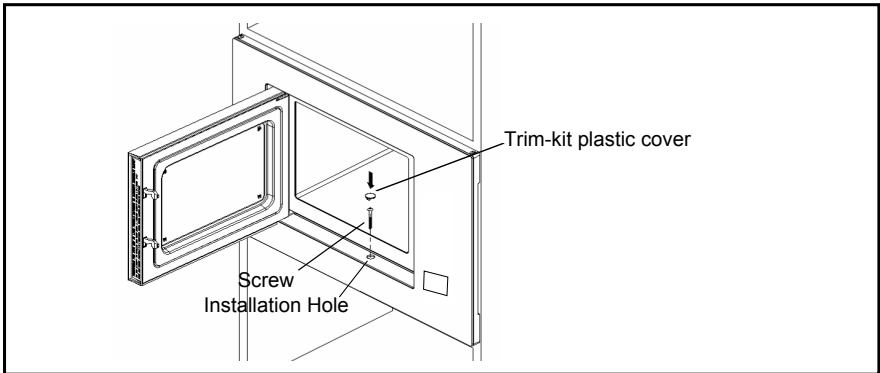

2. Open the door; fix the oven to the cabinet with SCREW at the INSTALLATION HOLE of TRIM KIT. Then fix the TRIM-KIT PLASTIC COVER to the INSTALLATION HOLE.

# Control Panel Instruction

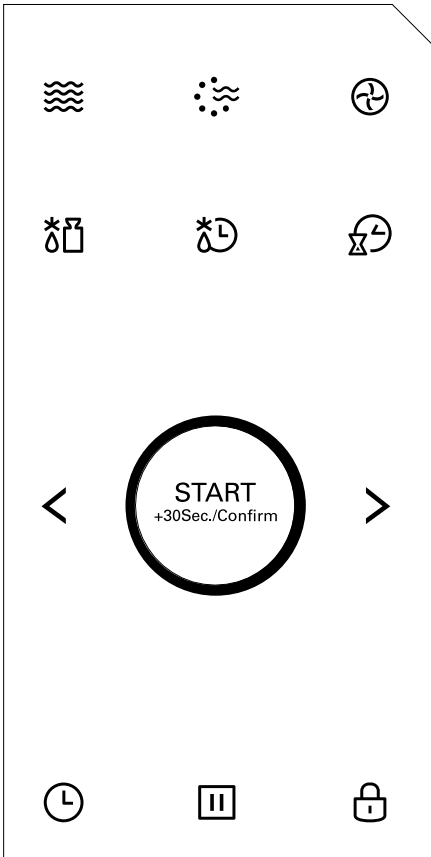



-  Microwave
-  Grill/Combi.
-  Convection
-  Weight Defrost
-  Time Defrost
-  Kitchen Timer
-  Clock

# Operation Instructions

This microwave oven uses modern electronic control to adjust cooking parameters to meet your needs better for cooking.

## 1. Clock Setting



When the microwave oven is electrified, the oven will display "0:00", buzzer will ring once.

- 1) In waiting state, press "  " once, the screen will display "00:00" and the hour figure will flash;
- 2) Press " < "or" > " to adjust the hour figures, the input time should be within 0--23.
- 3) Press " , the minute figures will flash.
- 4) Press " < "or" > " to adjust the minute figures, the input time should be within 0--59.
- 5) Press "  " to finish clock setting. ":" will flash,

Note: 1) The clock will not work if it is not set when powered.

- 2) During the process of clock setting, if you press "  ", the oven will go back to the previous status automatically.

## 2. Microwave Cooking

- 1) Press the "  " key once, and "P100" will display.
- 2) Press "  " repeatedly or press " < "and" > " to select the microwave power from 100% to 10%. "P100", "P80", "P50", "P30", "P10" will display in order.
- 3) Press " START " to confirm.  
+30Sec./Confirm
- 4) Press " < " or " > " to adjust the cooking time.  
(The time setting should be 0:05- 95:00.)
- 5) Press " START " to start cooking.  
+30Sec./Confirm

NOTE: the step quantities for the adjustment time of the coding switch are as follow:



- 0---1 min : 5 seconds
- 1---5 min : 10 seconds
- 5---10 min : 30 seconds
- 10---30 min : 1 minute
- 30---95 min : 5 minutes

## Microwave Power Chart

Microwave Power	100%	80%	50%	30%	10%
Display	P100	P80	P50	P30	P10



### 3. Grill or Combi. Cooking

Press "  " once the screen will display "G ", and press "  " repeatedly or press the " < " or " > " to choose the power you want, and "G", "C-1", "C-2", "C-3" or "C-4" will display. Then press " START <sub>+30Sec./Confirm</sub> " to confirm, and press " < " or " > " to set cooking time from 0:05 to 95:00. Press " START <sub>+30Sec./Confirm</sub> " again to start cooking.

Example: If you want to use Combi.(C-1) to cook for 10 minutes, you can operate the oven as the following steps.

- 1) Press "  " once, the screen display "G ".

---

- 2) Continue to press "  " until the screen displays "C-1".

---

- 3) Press " START <sub>+30Sec./Confirm</sub> " to confirm.

---

- 4) Press " < " or " > " to adjust the cooking time until the oven displays "10:00".

---



- 5) Press " START <sub>+30Sec./Confirm</sub> " to start cooking .

Combination Power instructions:

Function	Display	Microwave	Grill	Convection
Combi.1	C-1	●		●
Combi.2	C-2	●	●	
Combi.3	C-3		●	●
Combi.4	C-4	●	●	●

Note: If half the grill time passes, the oven sounds twice, and this is normal. In order to have a better effect of grilling food, you should turn the food over, close the door, and then press " START <sub>+30Sec./Confirm</sub> " to continue cooking. If no operation, the oven will continue working.

#### 4. Convection Cooking(with preheating function)

1) Press "  ", "130°C" will display and flash.Keep pressing "  " or press " < " or " > " to choose the convection temperature (130-220°C).

2) Press "  " to confirm the temperature.

3) Press "  " again to start preheating.

The temperature figure will flash when temperature arrives and buzzer will ring twice reminding you to put food in, then close the door.

4) Press " < " or " > " to adjust the cooking time (The maximum time is 95 minutes.)



5) Press "  " to start cooking.

Note: a. Cooking time cannot be input until the preheating temperature arrives.

If the temperature arrives, door must be opened to input the cooking time.

b. When the preheating time is more than 30 minutes and the temperature not arrives,buzzer will sound twice to tell you to input the cooking time. If the time not input in 5 minutes, the oven will stop preheating. The buzzer sound five times and turn back to waiting states.

#### 5. Convection Cooking(without preheating function)

1) Press "  ", "130°C" will display and flash.Keep pressing "  " or press " < " or " > "to choose the convection temperature (130-220°C).

2) Press "  " to confirm the temperature.

3) Press " < " or " > " to adjust the cooking time (The maximum time is 95 minutes.)

4) Press "  " to start cooking.

#### 6. Defrost By Weight

1) Press "  " once, the screen will display "dEF1".

2) Press " < " or " > " to select the food weight. The range of weight is 100-2000g.

3) Press "  " key to start defrosting.

#### 7. Defrost By Time

1) Press "  " once, the screen will display "dEF2".





2) Press " < " or " > " to select the cooking time.The maximum time is 95 minutes.

3) Press "  " key to start defrosting.



## 8. Multi-Stage Cooking

Two stages can be maximumly set. If one stages is defrosting, it should be put in the first stage automatically. The buzzer will ring once after each stage and the next stage will begin.

Example: if you want to defrost the food for 5 minutes, then to cook with 80% microwave power for 7 minutes. The steps are as following:

- 1) Press "  " once, the screen display "dEF2".
- 2) Press " < " or " > " to adjust the defrost time of 5 minutes;
- 3) Press "  " once, screen will display "P100".
- 4) Press " < " or " > " to choose microwave power till "P80" display;
- 5) Press "  " to confirm, screen will display "P80".
- 6) Press " < " or " > " to adjust the cooking time of 7 minutes;
- 7) Press "  " to start cooking.



## 9. Kitchen Timer

- (1) Press "  " once, screen will display 00:00.
- (2) Press " < " or " > " to enter the correct timer.  
(The maximum cooking time is 95 minutes)
- (3) Press "  " to confirm setting, timer indicator will be lighted.
- (4) When the kitchen time is reached, timer indicator will go out. The buzzer will ring 5 times.

If the clock be set(24-hour system), screen will display the current time.

Note: The kitchen time is different from 24-hour system, Kitchen Timer is a timer.





## 10. Auto Menu

- 1) In waiting state, press " > " to choose the menu from "A1" to "A10".
- 2) Press "  " to confirm the menu you choose.
- 3) Press " < " or " > " to choose the food weight.
- 4) Press "  " to start cooking.
- 5) After cooking finish, the buzzer sounds five times.

The menu chart:

Menu	Weight	Display	Power
A1 AUTO REHEAT	150g	150g	100%
	250g	250g	
	350g	350g	
	450g	450g	
	600g	600g	
A2 POTATO	1 (about230g)	1	100%
	2	2	
	3	3	
A3 MEAT	150g	150g	100%
	300g	300g	
	450g	450g	
	600g	600g	
A4 VEGETABLE	150g	150g	100%
	350g	350g	
	500g	500g	
A5 FISH	150g	150g	80%
	250g	250g	
	350g	350g	
	450g	450g	
	650g	650g	
A6 PASTA	50g(with cold water 450g)	50g	80%
	100g(with cold water 800g)	100g	
	150g(with cold water 1200g)	150g	
A7 SOUP	200ml	200	100%
	400ml	400	
	600ml	600	
A8 CAKE	475g	475g	preheat to 180°C
A9 PIZZA	200g	200g	C-4
	300g	300g	
	400g	400g	
A10 CHICKEN	500g	500g	C-4
	750g	750g	
	1000g	1000g	
	1200g	1200g	

## 11. Speedy Cooking





- 1) In waiting state, press " " key to cook with 100% power level for 30 seconds. Each press on the same key can increase 30 seconds. The maximum cooking time is 95 minutes.
- 2) During the microwave, grill, convection, combination cooking and time defrost process, press " " to increase the cooking time.
- 3) In waiting state, directly press " " to choose the cooking time and press " " to start the cooking.
- 4) Under the states of auto menu, multi-stage and defrost by weight, cooking time cannot be increased by pressing " ".

## 12. Lock Function for Children



Lock: In waiting state, press " " for 3 seconds, there will be a long beep denoting entering the children-lock state and the current time will display if the time has been set, otherwise, the screen will display "0:00".

Lock quitting: In locked state, press " " for 3 seconds, there will be a long "beep" denoting that the lock is released.

## 13. Inquiring Function

- 1) In cooking states of microwave, grill, convection and combination, press " ", " " or " " the current power will be displayed for 3 seconds.
- 2) During cooking state, press " " to check the current time. It will be displayed for 3 seconds.

## 14. Specification

- (1) " " must be pressed to continue cooking if the door is opened during cooking.
- (2) Once the cooking programme has been set, " " is not pressed in 5 minutes, the current time will be displayed. The setting will be cancelled.
- (3) The buzzer sounds once by efficient press, inefficient press will be no response.
- (4) The buzzer will sound five times to remind you when cooking is finished.

# Trouble shooting

Normal	
Microwave oven interfering TV reception	Radio and TV reception may be interfered when microwave oven operating. It is similar to the interference of small electrical appliances, like mixer, vacuum cleaner, and electric fan. It is normal.
Dim oven light	In low power microwave cooking, oven light may become dim. It is normal.
Steam accumulating on door, hot air out of vents	In cooking, steam may come out of food. Most will get out from vents. But some may accumulate on cool place like oven door. It is normal.
Oven started accidentally with no food in.	It is forbidden to run the unit without any food inside. It is very dangerous.

Trouble	Possible Cause	Remedy
Oven can not be started.	(1) Power cord not plugged in tightly.	Unplug. Then plug again after 10 seconds.
	(2) Fuse blowing or circuit breaker works.	Replace fuse or reset circuit breaker (repaired by professional personnel of our company)
	(3) Trouble with outlet.	Test outlet with other electrical appliances.
Oven does not heat.	(4) Door not closed well.	Close door well.



According to Waste of Electrical and Electronic Equipment (WEEE) directive, WEEE should be separately collected and treated. If at any time in future you need to dispose of this product please do NOT dispose of this product with household waste. Please send this product to WEEE collecting points where available.



# Service



[www.blaupunkt-einbaugeraete.com](http://www.blaupunkt-einbaugeraete.com)

 **1800 209 2096**

**India**

[customer\\_services@hepoindia.com](mailto:customer_services@hepoindia.com)